

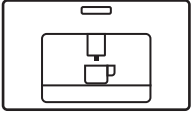

Electrolux



EN User Manual | Coffee machine

KBC85X

EBC85X

KBC85Z

KBC85T

Welcome to Electrolux! Thank you for choosing our appliance.



Get usage advice, trouble shooter, service and repair information at:
electrolux.com/support

Subject to change without notice.

CONTENTS

1. SAFETY INFORMATION	2
2. SAFETY INSTRUCTIONS	4
3. PRODUCT DESCRIPTION	6
4. CONTROL PANEL	7
5. BEFORE FIRST USE	7
6. DAILY USE	8
7. CARE AND CLEANING	11
8. DESCALING	12
9. SETTING WATER HARDNESS	12
10. WATER SOFTENER FILTER	12
11. TECHNICAL DATA	13
12. DISPLAY MESSAGE	13
13. TROUBLESHOOTING GUIDE	14

1. SAFETY INFORMATION

Before the installation and use of the appliance, carefully read the supplied instructions. The manufacturer is not responsible if an incorrect installation and use causes injuries and damages. Always keep the instructions with the appliance for future reference.

1.1 Children and vulnerable people safety

- The appliance is not intended for use by persons (including children) with reduced physical, sensory or mental capabilities, or lack of experience and knowledge, unless they are supervised or receive instructions concerning use of the application by a person responsible for their safety.
- Children should be supervised to ensure that they do not play with the appliance.
- For European markets only:
- This appliance can be used by children aged from 8 years and above if they have been given supervision or instruc-

tion concerning use of the appliance in a safe way and if they understand the hazard involved. Cleaning and user maintenance shall not be made by children unless they are older than 8 and supervised. Keep the appliance and its cord out of the reach of children aged less than 8 years.

- Children shall not play with the appliance.

1.2 General Safety

- Designated use: this appliance is designed and made to prepare coffee and milk based beverages and hot water. Any other use is considered improper and thus dangerous. The manufacturer is not liable for damage deriving from improper use of the appliance.
- The surface of the heating element remains hot after use and the outside of the appliance may retain the heat for several minutes depending on use.
- Clean all the components thoroughly, taking particular care with parts in contact with the coffee and milk.
- Cleaning and user maintenance shall not be made by children without supervision.
- Never submerge the appliance into water.
- CAUTION: To prevent damage to the appliance do not use alkaline cleaning agents when cleaning, use a soft cloth and a mild detergent.
- This is an household appliance only. It is not intended to be used in: staff kitchen areas in shops, offices and other working environments; farm houses; by clients in hotels, motels and other residential type environments; bed and breakfast type environments.
- If the plug or power cable is damaged, it must be replaced by customer services only to avoid all risk.
- Appliances with removable cord: avoid splashes of water on the power cord connector or socket at the back of the appliance.

- **WARNING:** Models with glass surfaces: do not use the appliance if the surface is cracked.
- For European markets only:
- Appliances can be used by persons with reduced physical, sensory or mental capabilities or lack of experience and knowledge if they have been given supervision or instruction concerning use of the appliance in a safe way and understand the hazards involved.
- When not in use and before cleaning, always unplug the appliance.



Surfaces marked with this symbol become hot during use (the symbol is present in certain models only).

2. SAFETY INSTRUCTIONS

2.1 Installation



WARNING!

Only a qualified person must install this appliance.

Read these instructions carefully before using the appliance.

- Keep these instructions
- Failure to respect these instructions may result in burns or damage to the appliance.
- Never touch the appliance with damp hands.
- Never touch the plug with damp hands.
- Make sure the socket used is freely accessible at all times, enabling the appliance to be unplugged when necessary.
- Unplug directly from the plug only.
- Never pull the power cable as you could damage it.
- To disconnect the appliance completely, place the main switch (A10) on the side of the appliance in the 0 position.
- If the appliance is faulty, do not attempt to repair.
- Turn it off using the main switch (A10), unplug from the mains socket and contact Customer Services.
- Keep all packaging (plastic bags, polystyrene foam) away from children.
- Install the appliance according to the instruc-

tions in the handbook to guarantee there are no spills when it is pulled out from the cabinet.

- The appliance has a cooling fan. This comes on whenever coffee, steam or hot water is delivered. After several minutes, the fan goes off automatically.

Cable types applicable for installation or replacement:

H05 VV-F, H05 V2V2-F (T90)

For the section of the cable refer to the total power on the rating plate. You can also refer to the table:

Total power (W)	Section of the cable (mm ²)
maximum 2300	3 x 1

The earth cord (green / yellow cable) must be 2 cm longer than phase and neutral cables (blue and brown cables).

2.2 Electrical connection



WARNING!

Risk of fire and electric shock.

- Check that the mains power supply voltage corresponds to the value indicated on the rat-

ing plate on the side of the appliance. Connect the appliance to an efficiently earthed and correctly installed socket with a minimum current rating of 10A only. If the power socket does not match the plug on the appliance, have the socket replaced with a suitable type by a qualified professional. To comply with safety directives, an omnipo- lar switch with a minimum contact distance of 3 mm must be installed.

Do not use multiple sockets or extensions.

- Safety cutout devices must be included in the mains power supply in compliance with the installation regulations in the country concerned.

2.3 Use



WARNING!

Risk of injury, burns and electric shock or explosion.

- This appliance produces hot water and steam may form while it is in operation. Avoid contact with splashes of water or hot steam. Use knobs and handles.
- Do not grasp the coffee maker when it is out of the cabinet.
Do not rest recipients containing liquids or inflammable or corrosive materials on top of the appliance. Place the accessories required to make the coffee (the measure for example) in the special holder.
Do not rest large objects which could obstruct movement or unstable objects on the appli-
ance.
Do not allow children and animals to stop or linger near the appliance when it is pulled out of the cabinet.
Do not leave the appliance pulled out of the cabinet when it is being used.
Do not leave the appliance pulled out of the cabinet when it is not needed.
- Do not use the appliance when extracted. Make sure the appliance is inactive before extracting it.
The only exception is adjusting the coffee mill which must be done with the appliance out (see the section "Adjusting the coffee mill").
- Use original or manufacturer recommended accessories and spare parts only.
- This appliance is designed and made to prepare coffee and heat drinks.

All other use is considered improper.

This appliance is not suitable for commercial use.

The manufacturer is not liable for damage deriving from improper use of the appliance. This appliance can be installed over a built-in oven if the latter is fitted with a cooling fan at the rear (maximum microwave power: 3 kW).

- The manufacturer is not liable for damage deriving from failure to respect these instruc-
tions.

2.4 Care and cleaning



WARNING!

Risk of injury, fire, or damage to the ap-
pliance.

- Before maintenance, deactivate the appli-
ance and disconnect the mains plug from the
mains socket.
- Make sure the appliance is cold. There is the
risk that the glass panels can break.
- Replace immediately the door glass panels
when they are damaged.
Contact the Authorised Service Centre.
- Be careful when you remove the door from
the appliance. The door is heavy!
- Clean regularly the appliance to prevent the
deterioration of the surface material.
- Clean the appliance with a moist soft cloth.
Use only neutral detergents. Do not use
abrasive products, abrasive cleaning pads,
solvents or metal objects.
- If you use an oven spray, follow the safety
instructions on its packaging.

2.5 Service

- To repair the appliance contact the Author-
ised Service Centre.
- Use original spare parts only.

2.6 Disposal



WARNING!

Risk of injury or suffocation.

- Disconnect the appliance from the mains sup-
ply.
- Cut off the mains electrical cable close to the
appliance and dispose of it.
- Remove the door catch to prevent children or
pets from becoming trapped in the appliance.

3. PRODUCT DESCRIPTION

3.1 General overview

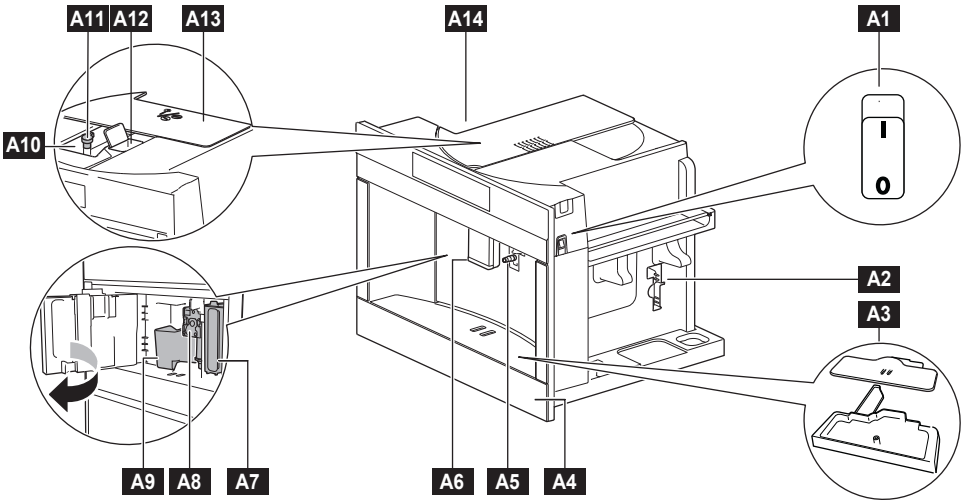

- A1** Main Switch
- A2** Accessories compartment (left/right)
- A3** Drip tray
- A4** Drip tray drop down cover
- A5** Hot water/steam connection nozzle
- A6** Coffee spout (adjustable height)
- A7** Pull out water tank
- A8** Brewing unit

- A9** Ground coffee waste container
- A10** Coffee bean container
- A11** Grinding adjustment dial
- A12** Ground coffee funnel
- A13** Rotating cover
- A14** Cup warming storage area (left)

Average temperature 35°C with cup warmer function enabled and automatic turning off set to at least 2 hours

3.2 Accessories

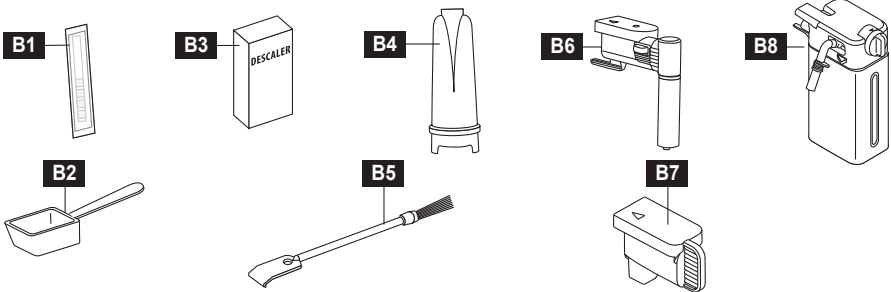

- B1** "Total Hardness Test" indicator paper
- B2** Ground coffee measure
- B3** Descaler *
- B4** Water Softener Filter *

- B5** Cleaning brush
- B6** Hot water/steam spout
- B7** Connection nozzle cover
- B8** Milk container

(*) Available on certain models only

4. CONTROL PANEL

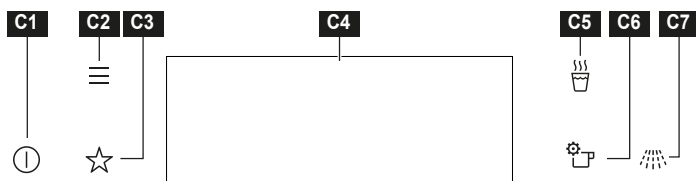

	Icons	Function	Description
C1		ON/OFF	To activate and deactivate the machine. A long press (3 sec.) of this key will turn off the heaters.
C2		MENU	Lists the functions (cleaning, favourites, options, settings).
C3		FAVOURITES	Lists the favourite settings.
C4		DISPLAY	Shows the current settings of the coffee machine
C5		HOT WATER	To make a hot water beverage
C6		BEVERAGE OPTIONS	To set beverage options (Aroma, Size, Cups, Milk) and functions (Save options as default, Save as favourite, Reset options, Remove favourite). Aroma: Extra mild, Mild, Normal, Strong, Extra strong, Pre-ground Size: Small, Medium, Large, Extra large Cups: 1 cup, 2 cups Milk: from 10% to 90%
C7		RINSING	To clean and heat the machine



Press Touch the surface with fingertip.



Move Slide fingertip over the surface.

5. BEFORE FIRST USE



WARNING!

Refer to Safety chapters.

1. Clean the machine before first use



Refer to “Care and cleaning” chapter.

2. Connect the machine

Connect the machine to the mains electricity supply and switch ON the main switch **A1**

3. Setting and rinsing

Follow the instructions on the display.

6. DAILY USE

WARNING!

Refer to Safety chapters.

NOTE ON ENERGY CONSUMPTION

In order to fulfill the Energy consumption requirements the coffemachine is set as Default with 30minutes READY TO USE state.

During this period of time the heaters are on and the coffemachine is ready for the use.

A shorter or longer "Keep Warm" Time (Ready To Use) can be set inside the MENU.











When the machine is turned on and not in Ready to be used status, it performs an automatic preheat and rinse cycle which cannot be interrupted. The machine is ready for use only after completion of this cycle.

Preparation of each beverage can be customised by pressing  Beverage options icon and saved as a favourite or save options as default; this feature allows the User to save the current settings.

The  Favourites icon on the control panel allows the user to prepare their favourite beverage directly.

6.1 Set the desired beverage

Icons	Beverage
	Ristretto
	Espresso
	Espresso lungo
	Long coffee
	Americano

Icons	Beverage
	Espresso macchiato
	Macchiato
	Cappuccino
	Cappuccino +
	Latte macchiato
	Flat white
	Caffe latte
	Milk
	Hot water
	Steam
	Jug

6.2 Making coffee

1. Place a cup (or two cups) under the coffee spouts **A6**.
2. Lower the spouts as near as possible to the cup. This makes a creamier coffee;
3. Select the desired coffee: Ristretto, Espresso, Espresso lungo, Long Coffee, Americano.



4. Is it possible to customize Aroma, coffee quantity and number of cups by pressing **B6** Beverage options icon.
5. You can change the number of cups between 1 and 2, quickly with the **B6** icon.
6. Press START and the beverage delivery begins

6.3 Adjusting the coffee mill

⚠ CAUTION

Select a coffee beverage with extra strong taste and turn the grinding adjustment dial when the grinding is operating (Sound of grinding).

Dial position	Recommended for...
	Turn clockwise (high number/coarser grind) for a less dense crema. Rotate slowly 1 step at time while the grinding is operating (sound of grinding).
	Turn anticlockwise (lower number/finer grind) for a denser crema. Rotate slowly 1 step at time while the grinding is operating (sound of grinding).

If the message "GROUND TOO FINE" appears on the display, and coffee is not dispensed, rotate the knob of 1 or 2 steps clockwise.

You may need to serve at least 2 drinks to notice the adjustment.

6.4 Pre-ground coffee

1. Add one level measure of pre-ground coffee only when the machine is on.

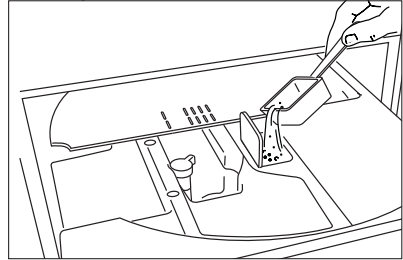

2. Press **B6** Beverage options icon, select 'Pre-ground' and press OK icon.
3. Press START icon. Preparation begins.

6.5 Making automatic beverages with milk

1. Remove the hot water/steam spout **B6**;
2. Fill the milk container **B8** with a sufficient quantity of milk, not exceeding the MAX level marked on the container.
3. Insert the milk container **B8** to the Steam connection nozzle **A5** until the acoustic signal.
4. Place a cup under the coffee spouts.
5. Select the desired milk beverage: Espresso macchiato, Macchiato, Cappuccino, Cappuccino+, Latte macchiato, Flat white, Caffè latte, Milk.
6. Press START icon. Preparation begins.

Turn the froth adjustment dial on the milk container lid to adjust the amount of froth on the milk:

Dial position	Recommended for...
	Caffè latte / Hot milk
	Latte macchiato
	Cappuccino / Milk (frothed milk)

6.6 Making milk beverages with the Steam Spout.

1. Insert the Steam Spout **B6** into the Steam connection nozzle **A5** and select the STEAM function on the display.
2. Press START to begin.

6.7 Autostart

You can set the Auto-start time in order to have the machine ready to use at a certain time (for example in the morning) so you can make coffee immediately. Inside the Menu can be set the preferred time. To enable this function, the time must already be set correctly.

6.8 Ready to use (keep warm)

The machine can be programmed to stay in Ready to use status from 15min to 3 hours. Inside the Menu can be set the preferred period of time.

During this period of time the machine is ready to be used and the heaters are on. Time set from manufacturer is 30 minutes.

7. CARE AND CLEANING

WARNING!

Refer to Safety chapters.



Clean the coffee machine

To clean the coffee machine select “Menu”, then “Cleaning”, “Cleaning guide” and then “Machine cleaning”. Follow the instructions on the display.

The following parts of the machine must be cleaned regularly and let them dry: coffee ground container, drip tray, water tank and coffee spouts. Use a soft cloth with warm water and a mild detergent. None of these components of the machine can be washed in a dishwasher. Do not use solvents, abrasive detergents or alcohol to clean the coffee machine. Check regularly that the ground coffee funnel is not blocked. If necessary, remove coffee deposits with the brush supplied.

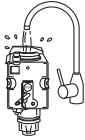

Brewing unit

The brewing unit **A8** can be removed only when the machine is off (Not in Ready to Use state), by pressing  ON/OFF icon for 3 seconds. Press the two coloured release buttons inwards and at the same time pull the brewing unit outwards. Do not use washing up liquid to clean the brewing unit. It would remove the lubricant applied to the inside of the piston. Soak the brewing unit in water for about 5 minutes, then rinse. **DO NOT PUT THE BREWING UNIT INTO THE DISHWASHER.**



Rinsing

If the machine is not used for more than 3/4 days, before using it again, we strongly recommend switching it on and performing 2-3 rinse cycles by pressing  icon.

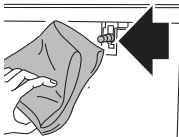

Hot water/steam connection nozzle

Each time you prepare milk, clean the hot water/steam connection nozzle **A5** with a clean cloth to remove milk residues from the gaskets.

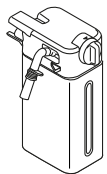

Milk container

components

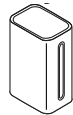

dishwasher



To clean the Milk container **B8** select “Menu”, then “Cleaning”, “Cleaning guide” and then “Milk jug cleaning”. Follow the instructions on the display.

Make sure there are no milk residues on the hollow and groove under the dial. If necessary, scrape the groove with a toothpick.



components

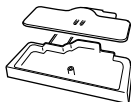

dishwasher



Drip tray and ground coffee waste container

8. DESCALING

The machine is developed to detect when it is time to run a descaling process.

To perform an autonomous descaling process, please follow the below steps:

1. Remove the water softener filter **B4** from the pull out water tank **A7**
2. Select "Menu" and then "Cleaning".
3. Select "Descaling" and follow the instructions on the display.

The descaling cycle cannot be canceled, but only temporarily interrupted by pressing STOP.

Use only descaler authorised by the manufacturer:

WebShop ELECTROLUX:

www.electrolux.com/shop

cod. **9029798718 M3BICD200**

9. SETTING WATER HARDNESS

The machine is set by default for a hardness level of 4. The machine can also be programmed according to the hardness of the mains water in the various regions so that the machine needs to be descaled less often.

9.1 Measuring water hardness

1. Remove the "Total hardness test" **B1** (attached to the Quick guide) indicator paper from its packaging.
2. Immerse the paper completely in a glass of water for one second.
3. Remove the paper from the water and

shake lightly. After about a minute, 1, 2, 3, or 4 red squares form, depending on the hardness of the water. Each square corresponds to one level.

9.2 Setting water hardness

1. Select "Menu" and then "Settings".
2. Select "Setup" then "Water Hardness" and set the required level from 1 to 4 (Level 1 = soft water; Level 4 = very hard water);

The machine is now reprogrammed with the new water hardness setting.

10. WATER SOFTENER FILTER

Certain models are fitted with a water softener filter **B4**. If this is not the case with your model, you are recommended to purchase one from Customer Services. The filter lasts about two months if the machine is used normally. If the coffee machine is left unused with the filter installed, it will last a maximum of 3 weeks.

10.1 Installing the filter

1. Remove the filter from its packaging.
2. Select "Menu" and then "Cleaning".
3. Select "Water filter" then "Install/Replace" and follow the instructions on the display.

10.2 Remove the filter

1. Select "Menu" and then "Cleaning".
2. Select "Water filter" then "Remove (if installed)" and follow the instructions on

the display.

Use only water filter authorised by the manufacturer:

WebShop ELECTROLUX:

www.electrolux.com/shop

cod. **9029798726 M3BICF200**

11. TECHNICAL DATA

Voltage: 220-240 V~ 50-60 Hz max. 10A
 Absorbed power: 1350W
 Pressure: 15 bar
 Water tank capacity: 2.5 litres
 Size: LxHxD: 594x454x412mm
 Weight: 20 kg



This appliance conforms to EC Regulation 1935/2004 concerning materials and articles intended to come into contact with food.



The appliance must not be disposed of with household waste, but taken to an authorised waste separation and recycling centre.

12. DISPLAYED MESSAGES

Displayed message	Possible cause	Action
EMPTY GROUND COFFEE WASTE CONTAINER	The ground container is full.	Empty the ground coffee waste container, clean and replace. IMPORTANT: the container might not be full. This is a normal cleaning message to prevent from mold creation after some time.
INSERT THE GROUND COFFEE WASTE CONTAINER	The ground coffee waste container is not positioned correctly.	Insert correctly after cleaning the ground coffee waste container.
ADD PRE-GROUND COFFEE	The pre-ground coffee function has been selected without placing any pre-ground coffee in the funnel.	Place pre-ground coffee in the funnel and repeat delivery
	The pre-ground coffee funnel is clogged.	Empty the funnel with the help of a brush.
GROUND TOO FINE. ADJUST GRIND LEVEL CLOCKWISE	The grinding is too fine and the coffee is delivered too slowly or not at all.	Repeat coffee delivery and turn the grinding adjustment dial one click clockwise towards "7" while the coffee mill is in operation. If after making at least 2 coffees delivery is still too slow, repeat the correction procedure, turning the grinding adjustment dial another click until delivery is correct. If the problem persists, make sure the water tank is fully inserted.
	If the softener filter is present, an air bubble may have been released inside the circuit, obstructing delivery.	Insert the hot water/steam spout in the machine and deliver a little water until the flow becomes regular.
TOO MUCH POWDER. SELECT A Milder TASTE OR REDUCE THE AMOUNT OF PRE-GROUND COFFEE	Too much coffee has been used.	Select a milder taste or reduce the quantity of pre-ground coffee (maximum 1 measure).
INSERT BREWING UNIT	The brewing unit is not placed in the correct position	Insert the brewing unit correctly in position after cleaning.
PLEASE DESCALE YOUR MACHINE	The machine must be descaled.	Follow the instructions on the display and the procedure

Displayed message	Possible cause	Action
PLEASE DESCALE YOUR MACHINE. YOU HAVE ## BEVERAGES LEFT.	The machine must be descaled.	Press DESCALE to start descaling. Follow the instructions on the display and follow the procedure.
REPLACE WATER SOFTNER FILTER	The softener filter is exhausted.	Follow the instructions on the display to replace or remove the filter. Follow the instructions in section "Water softener filter".
GENERAL ALARM: REFER TO USER MANUAL	The inside of the machine is very dirty.	Clean the inside of the machine thoroughly, as described in the section "Cleaning". If the message is still displayed after cleaning, contact Customer Services.
STORE MILK CONTAINER IN THE FRIDGE	The milk container was inserted in the machine for + 20 min	Remove the milk container from the machine and place it in the fridge.
ASSEMBLE THE SPOUT ON THE MILK CONTAINER	Request for a milk drink for the first time	Follow the instructions on the display.

13. TROUBLESHOOTING GUIDE

Problem	Possible cause	Solution
The coffee is not hot.	A low coffee temperature is set.	Set a hotter coffee temperature in the menu.
	The cups were not preheated.	Warm the cups with hot water using the dedicated key on the display C5 . Throw away the water and dry carefully the cups.
	The machine has cooled down because some time passed since the last coffee was made.	Heat up the coffee spouts by rinsing using the dedicated key on the display C7 .
	The machine must be descaled	Proceed as described in section "Descaling". Next, check the water hardness ("Measuring water hardness") and make certain the machine setting matches the local water supply hardness ("Setting water hardness").

Problem	Possible cause	Solution
The coffee is weak or not creamy enough.	The coffee is ground too coarsely.	Turn the grinding adjustment dial one click anticlockwise towards "1" while the coffee mill is in operation. Continue one click at a time until coffee delivery is satisfactory. The effect is only visible after delivering 2 coffees (see section "Adjusting the coffee mill").
	Coffee not fresh.	The coffee pack has been opened for too long and has lost its taste.
	The coffee is unsuitable.	Use coffee for espresso machines.
The coffee is delivered too slowly or a drop at a time.	The coffee is ground too finely.	Turn the grinding adjustment dial one click clockwise towards "7" while the coffee mill is in operation. Continue one click at a time until coffee delivery is satisfactory. The effect is only visible after delivering 2 coffees (see section "Adjusting the coffee mill").
Coffee does not come out of one or both of the spouts.	The coffee spouts are blocked.	Clean the spouts with a toothpick and run a rinsing process.
The machine does not turn on	It is not plugged into the mains socket.	Plug into the mains socket.
	The main switch is not turned on.	Press the main switch A1 .
The brewing unit cannot be extracted	The machine has not been turned off correctly	Turn the machine off by pressing for 3 seconds the  ON/OFF icon
At the end of descaling, the machine requests a third rinse	During the two rinse cycles, the water tank has not been filled to the MAX level	Follow the instructions displayed by the machine, but first empty the drip tray to avoid the water overflowing.
The milk does not come out of the milk spout	The lid of the milk container is dirty	Clean the milk container lid
The milk contains large bubbles and squirts out of the milk spout or there is little froth	The milk is not cold enough or is not semi-skimmed or skimmed.	Use skimmed or semi-skimmed milk at refrigerator temperature (about 5° C). If the result is not as you wished, try changing brand of milk.
	The froth adjustment dial is incorrectly adjusted.	Adjust following the instructions in section "Adjusting the amount of froth".
	The milk container lid or froth adjustment dial is dirty	Clean the milk container lid and froth adjustment dial as described in section "Cleaning the milk container".
	The hot water/steam connection nozzle is dirty	Clean the connection nozzle as described in section "Cleaning the hot water/steam connection nozzle".
The machine emits noises or small puffs of steam while not in use	The machine is ready for use, or has recently been turned off, and condensate is dripping into the hot vapouriser	This is part of normal operation. To limit the phenomenon, empty the drip tray.

electrolux.com

DEMO MODE CODE: 2.4.6.8

To exit from Demo mode, select "Setting", then "Service" and then "Demo Mode ON/OFF".

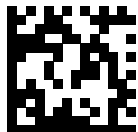

57132C7663_02_0622

