



de Montageanleitung
en Installation instructions
fr Notice d'installation
nl Installatie-instructies
it Istruzioni d'installazione
el Οδηγίες εγκατάστασης
es Instrucciones de montaje
pt Instruções de instalação
sv Installationsanvisningar
no Installasjonsveiledning
fi Asennusohjeet
da Installationsvejledning
tr Kurulum talimatları
ru Инструкция по установке
cs Pokyny k instalaci
pl Instrukcje montażu
hu Telepítési útmutató
hr Upute za instalaciju
mk Упатства за инсталирање
sl Navodila za montažo

sr Uputstva za montažu
et Paigaldusjuhised
lt Įrengimo instrukcijos
lv Uzstādīšanas instrukcijas
sq Udhëzimet e instalimit
fa دستورالعمل نصب
ar تعليمات التركيب
ko 설치 설명서
zh 安装说明
uk Інструкція з монтажу
ro Instrucțiuni de instalare
bg Инструкции за монтаж
ja 設置説明書
he הוראות התקנה
id Petunjuk pemasangan
kk Орнату нұсқаулықтар
zh-hk 安裝說明
zh-tw 安裝說明
uz O'rnatish bo'yicha yo'riqnomalar





| | | | |
|-----------|---|--------------|---|
| de | über den Kundendienst erhältlich | sl | na voljo prek pooblaščenega servisa |
| en | Available from our after-sales service | sr | može se dobiti preko korisničkog servisa |
| fr | disponible via le service après-vente | et | saadaval hooldekeskuse kaudu |
| nl | bij de servicedienst verkrijgbaar | lt | galima įsigyti klientų aptarnavimo tarnyboje |
| it | disponibile presso il servizio di assistenza clienti | lv | var saņemt klientu apkalpošanas dienestā |
| el | διαθέσιμο από την υπηρεσία εξυπηρέτησης πελατών | sq | marrja e mundshme përmes shërbimit të klientit |
| es | disponible a través del Servicio de Atención al Cliente | fa | در مرکز خدمات مشتریان موجود است |
| pt | pode ser adquirido nos nossos Serviços Técnicos | ar | يمكن الحصول عليها من خدمة العملاء |
| sv | går att beställa via service | ko | 고객 서비스센터를 통해 구입 가능 |
| no | fås hos kundeservice | zh | 可向客户服务索取 |
| fi | saatavissa huoltopalvelusta | uk | Через сервісну службу |
| da | Fås hos kundeservice | ro | se pot obține de la serviciul de asistență pentru clienți |
| tr | müşteri hizmetlerinden temin edilebilir | bg | предоставя се от службата за обслужване на клиенти |
| ru | можно приобрести через сервисную службу | ja | カスタマーサービスを通じて入手可能 |
| cs | k dostání v zákaznickém servisu | he | זמין דרך שירות הלקוחות |
| pl | do nabycia w punkcie serwisowym | id | Tersedia di Layanan Pelanggan |
| hu | a vevőszolgálaton keresztül kapható | kk | сервистік қызмет арқылы алуға болады |
| hr | može se kupiti kod servisne službe | zh-hk | 可向售後服務站索取 |
| mk | достапно преку сервисната служба | zh-tw | 可向客戶服務單位索取 |
| | | uz | otishdan keyingi xizmat orqali olish mumkin |

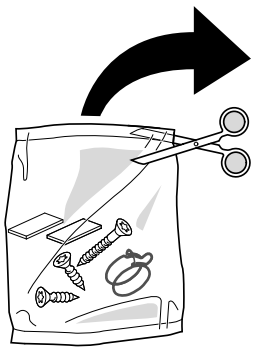

Ø4X36 Ø4X30

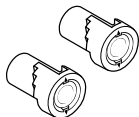
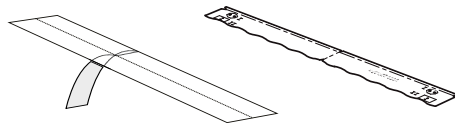
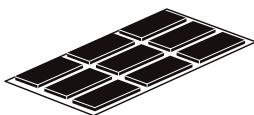

Ø4X15

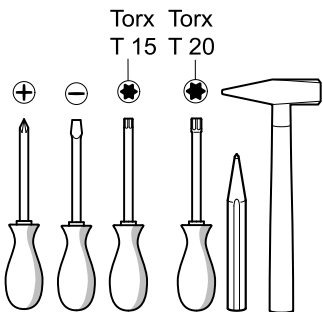
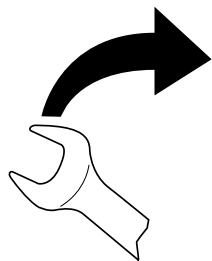
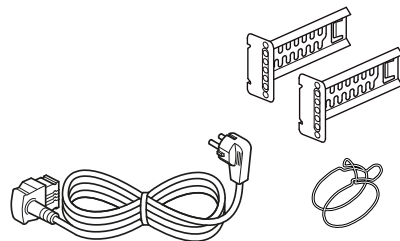
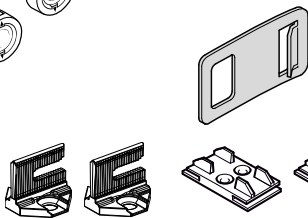
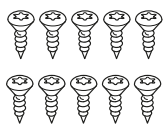

Torx
T 15 T 20

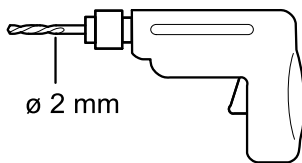
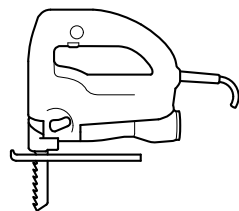
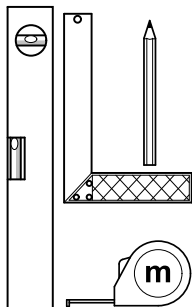
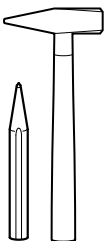

SW13

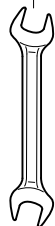

SW10

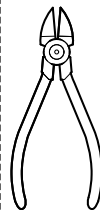
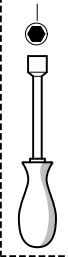

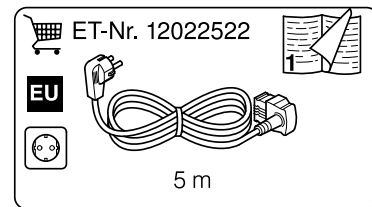
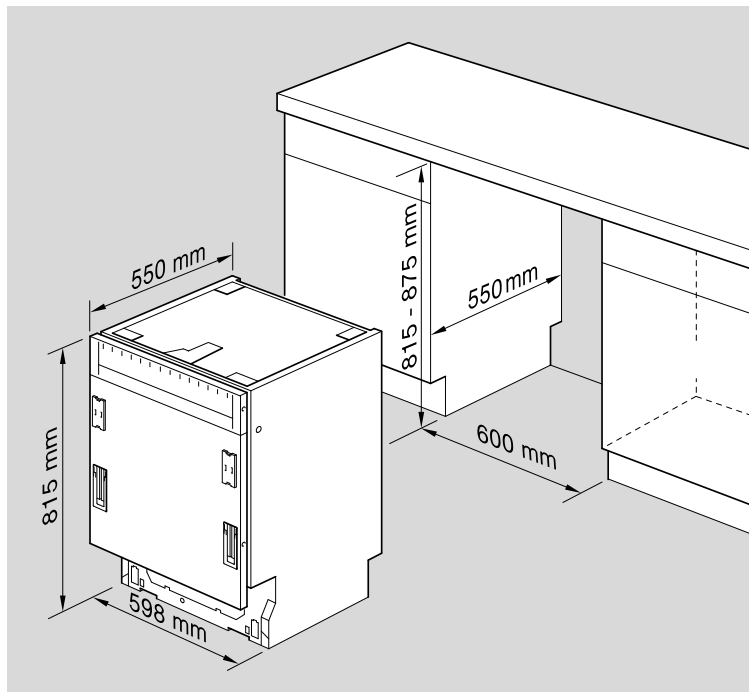
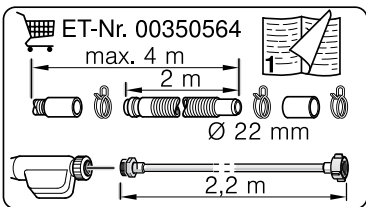
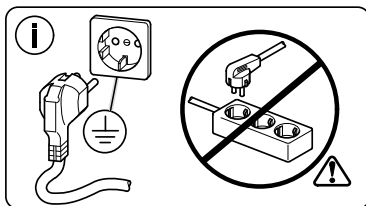
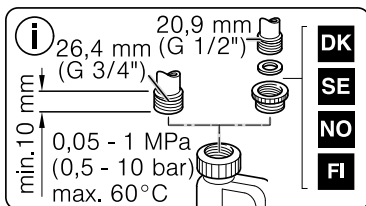
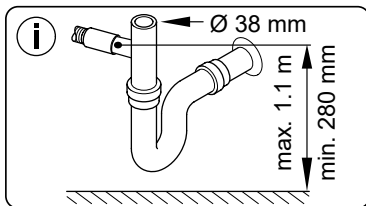

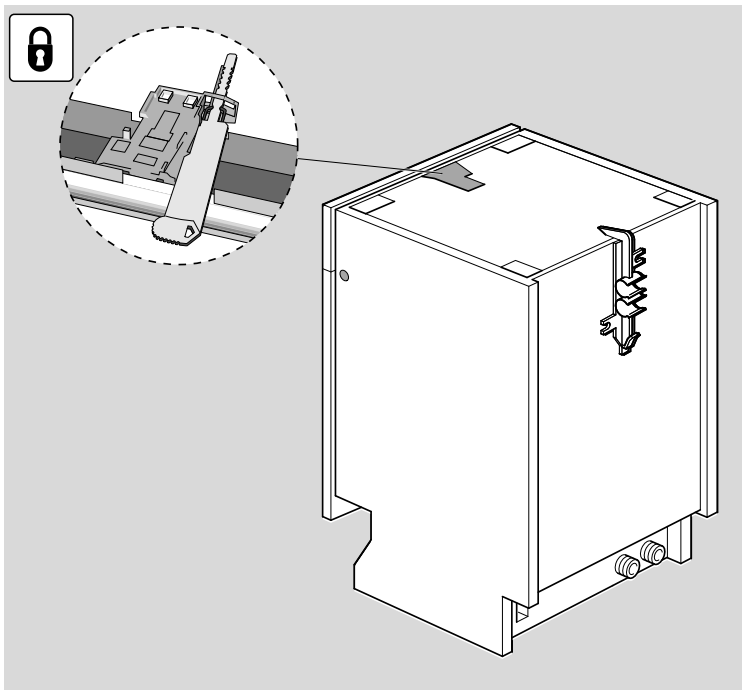
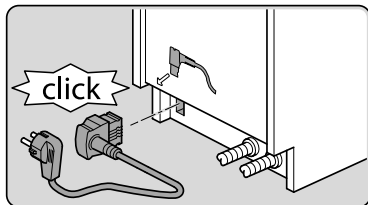
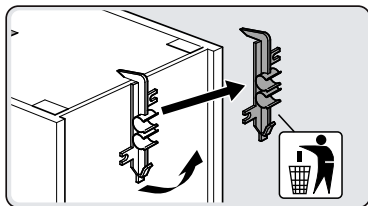
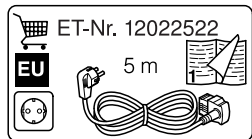
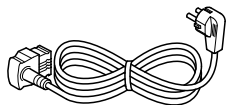

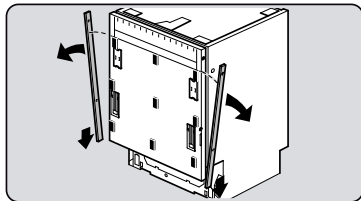
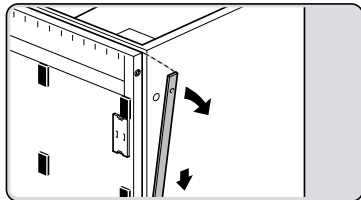
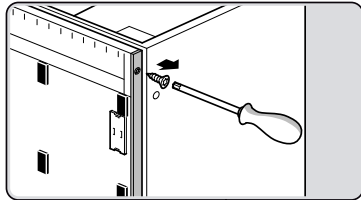
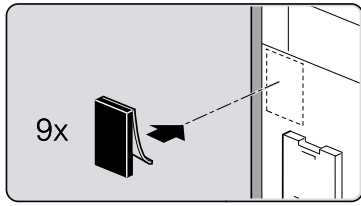
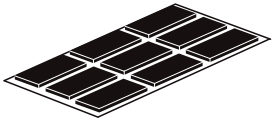

Torx
T 15

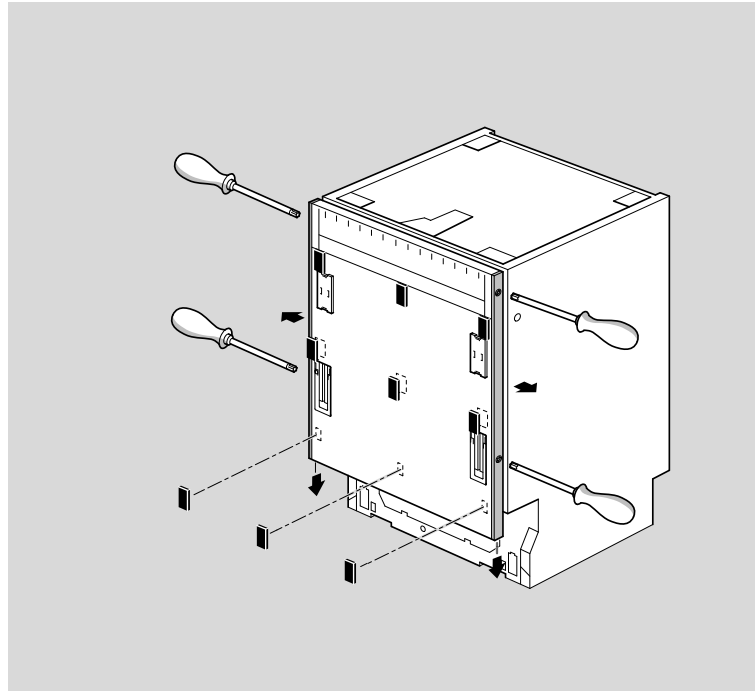

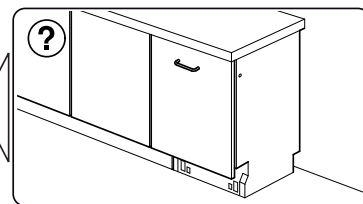
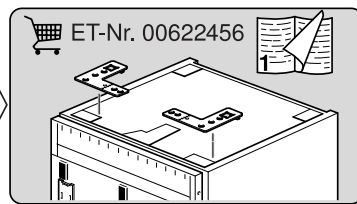
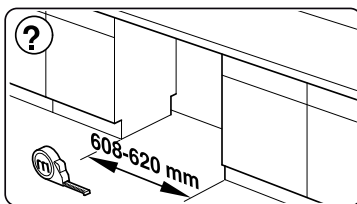
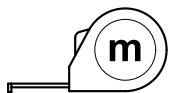
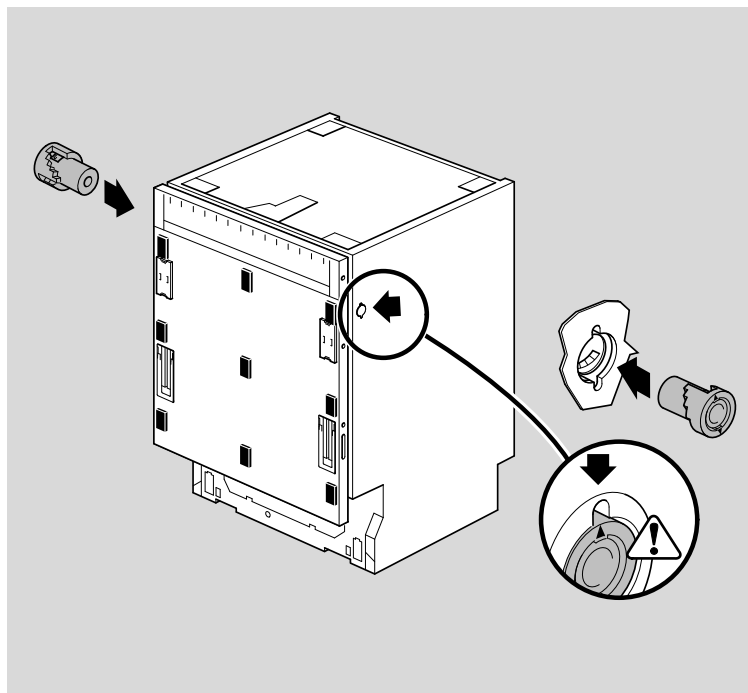
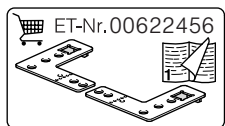
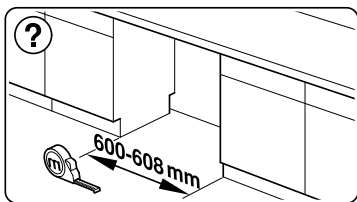
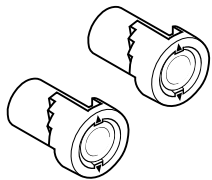

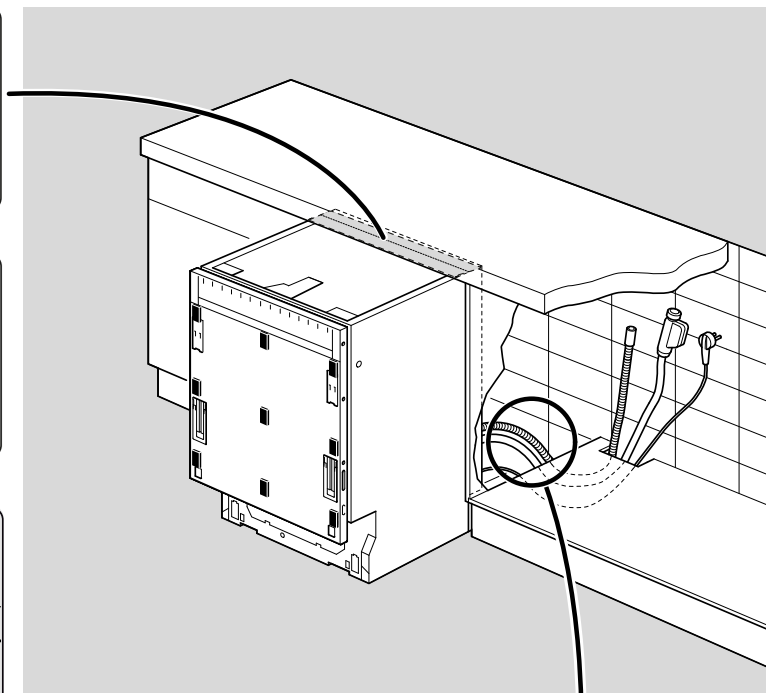
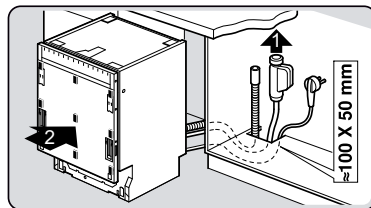
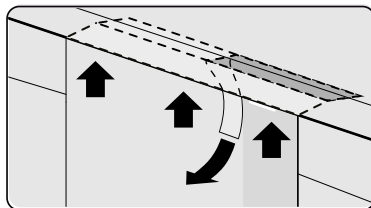
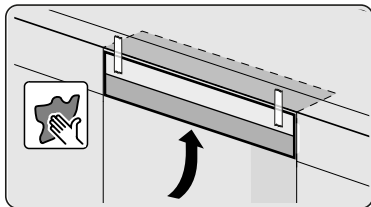
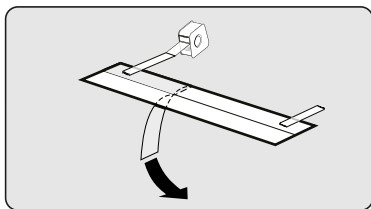
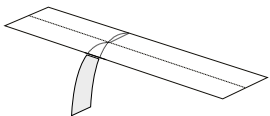

nicht einklemmen
do not pinch
ne pas coincer
No doblar

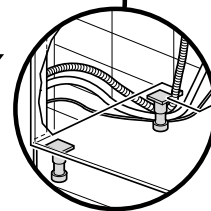

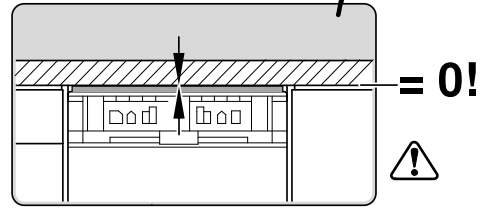
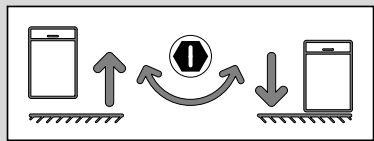
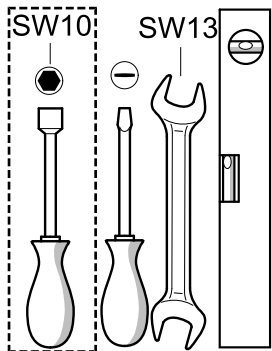
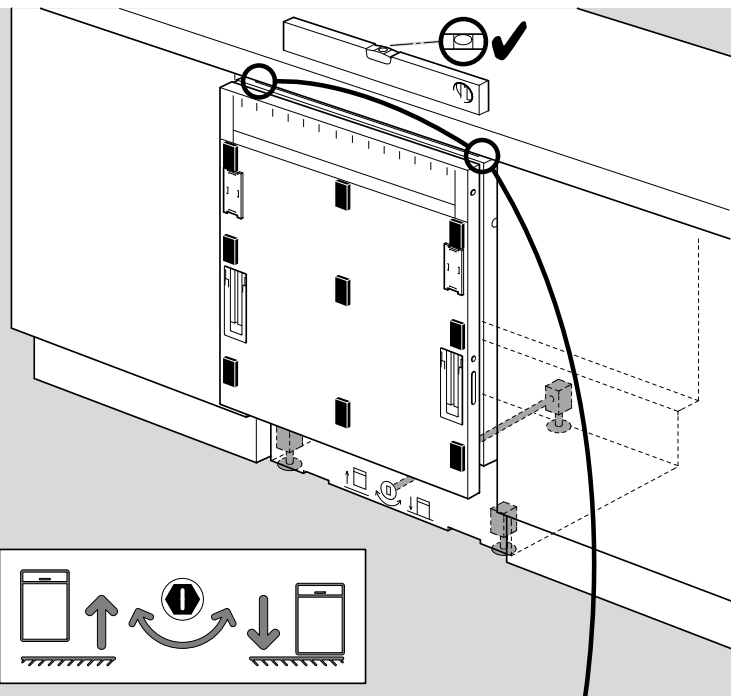
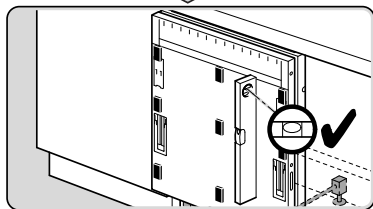
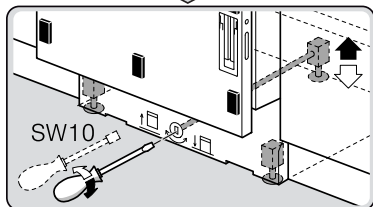
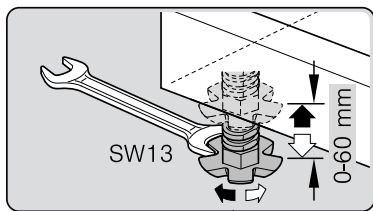

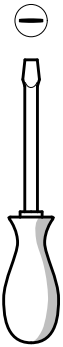
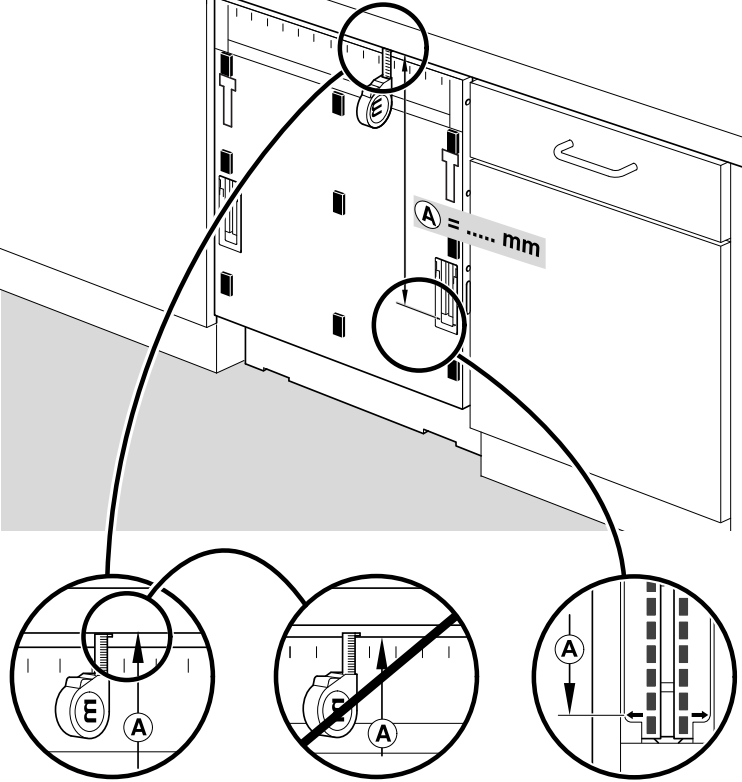
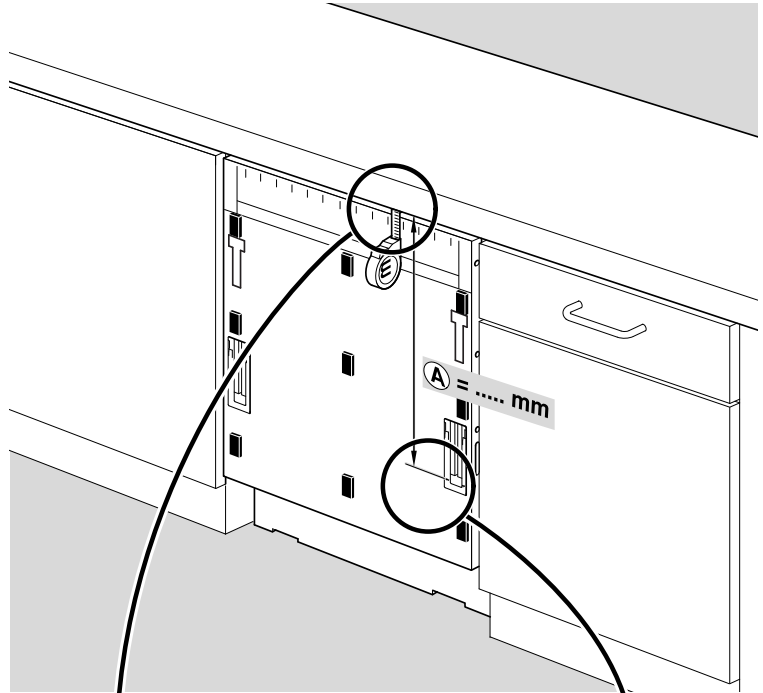
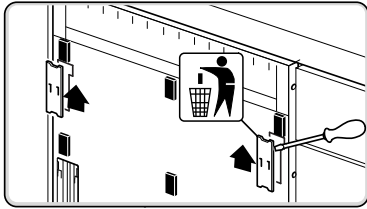

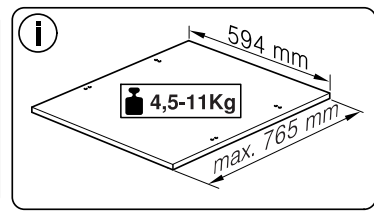
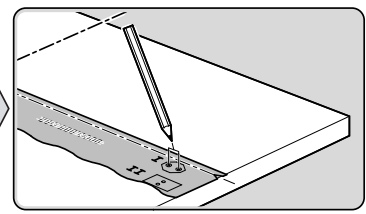
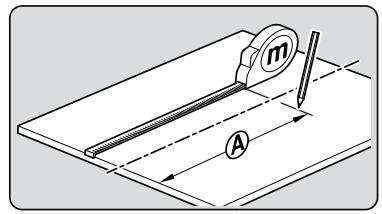
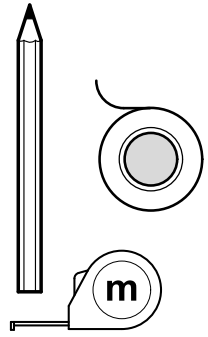
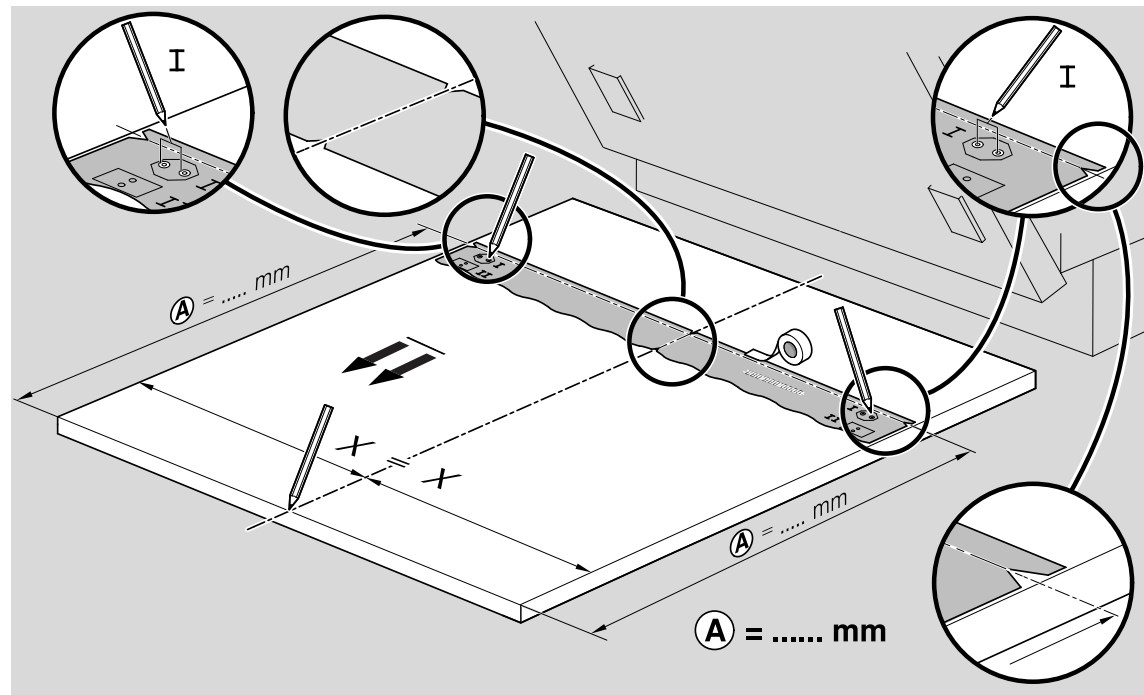
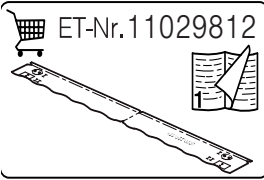
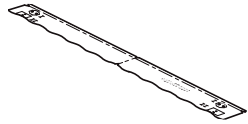

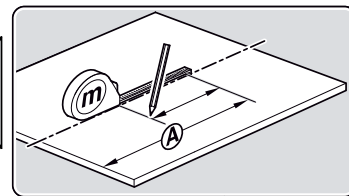
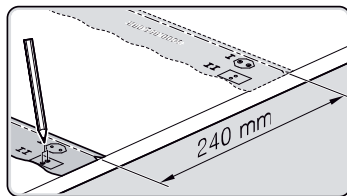
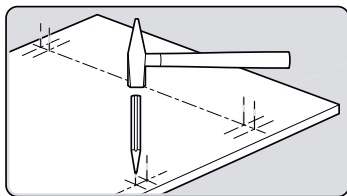
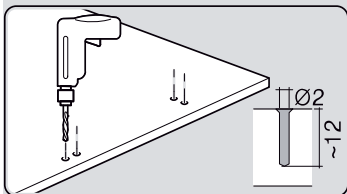
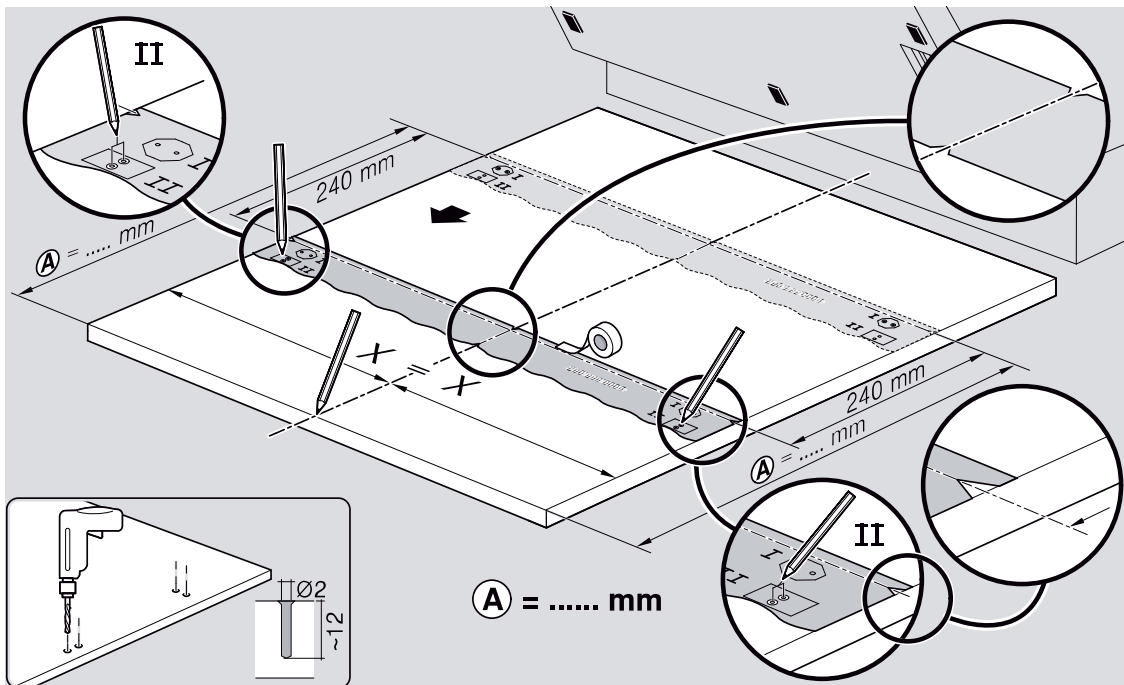
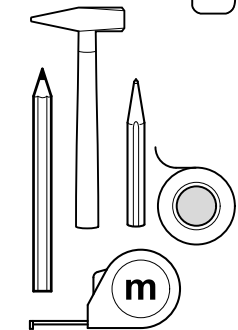
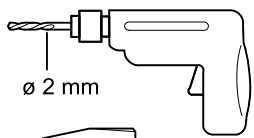
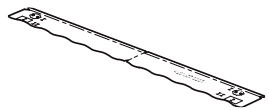

Ø4X15

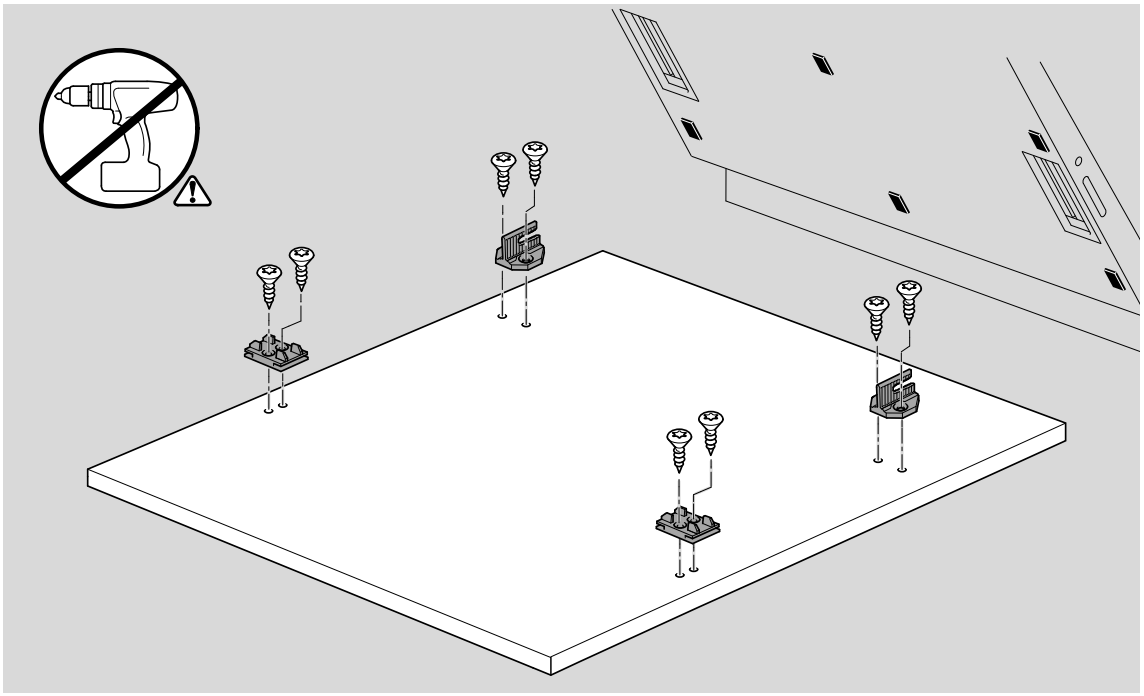
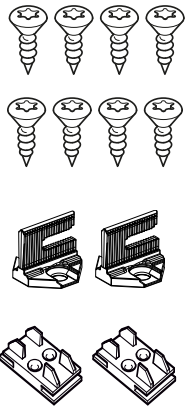

Torx
T 20

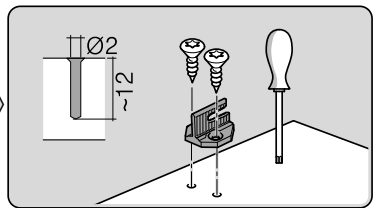
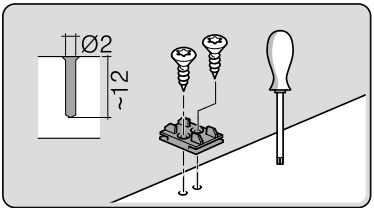
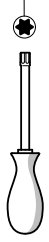

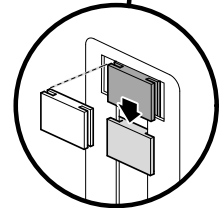
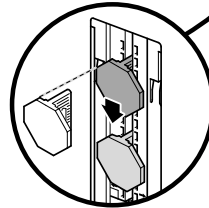
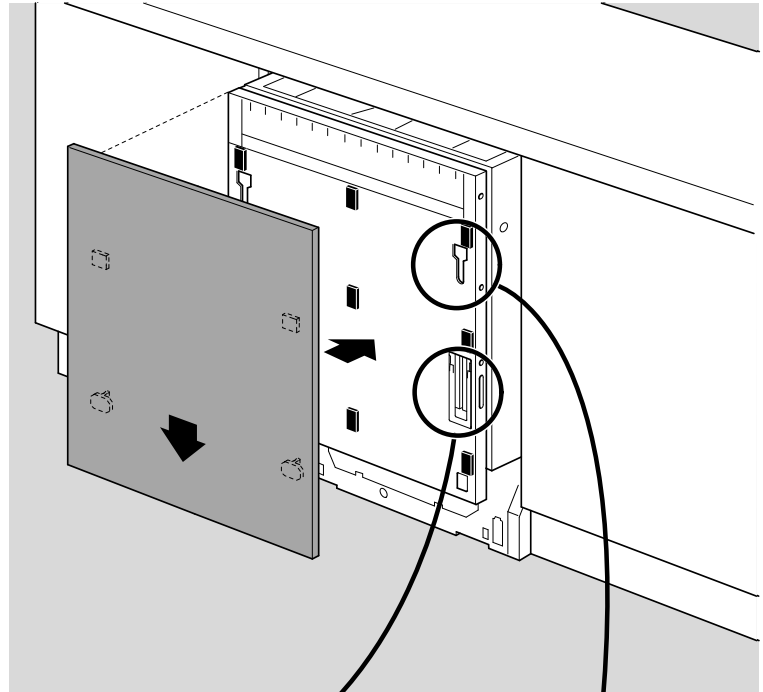
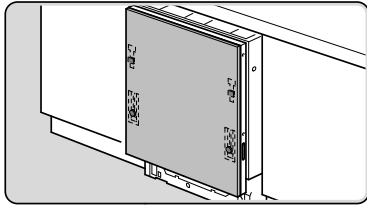

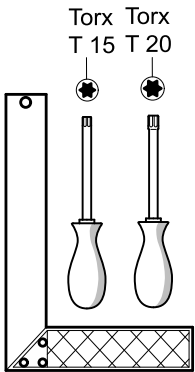
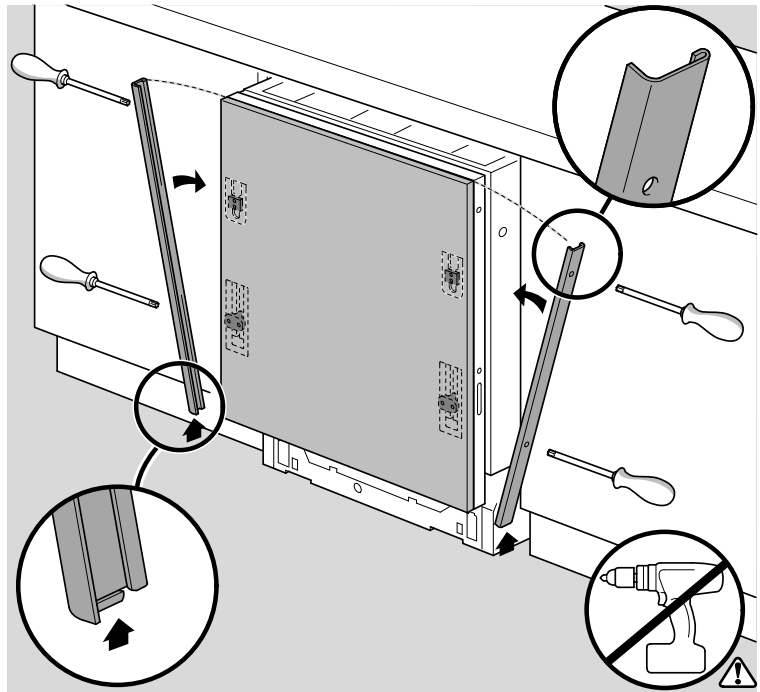
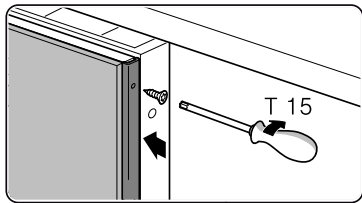
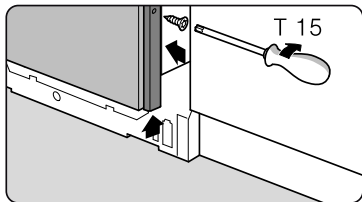
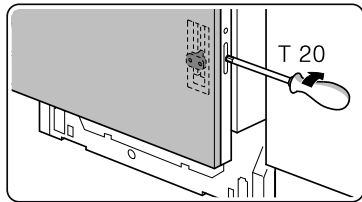
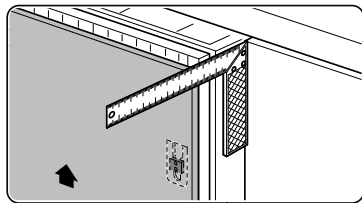

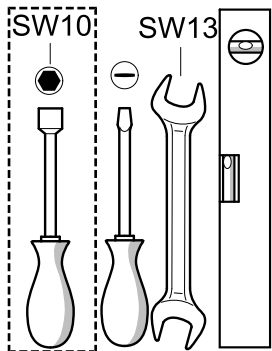
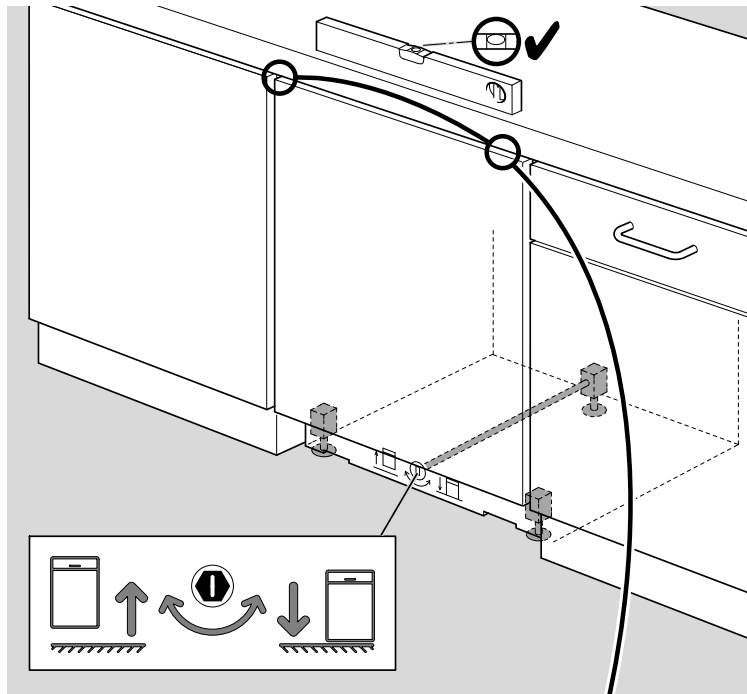
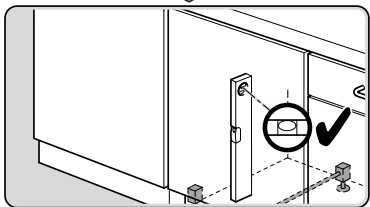
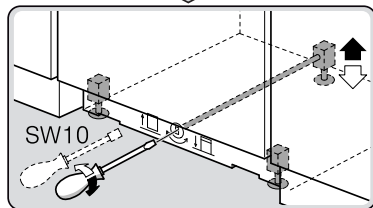
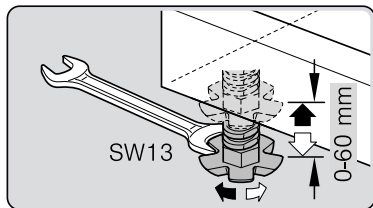

verspannen
brace
calar verticalement
Enrasar

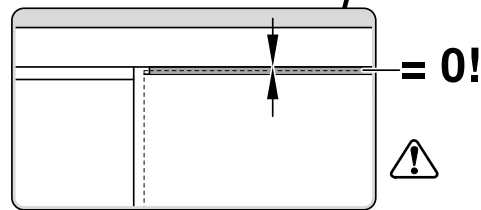

Ø4X30

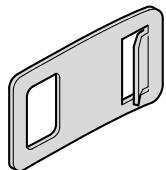

Torx
T 20

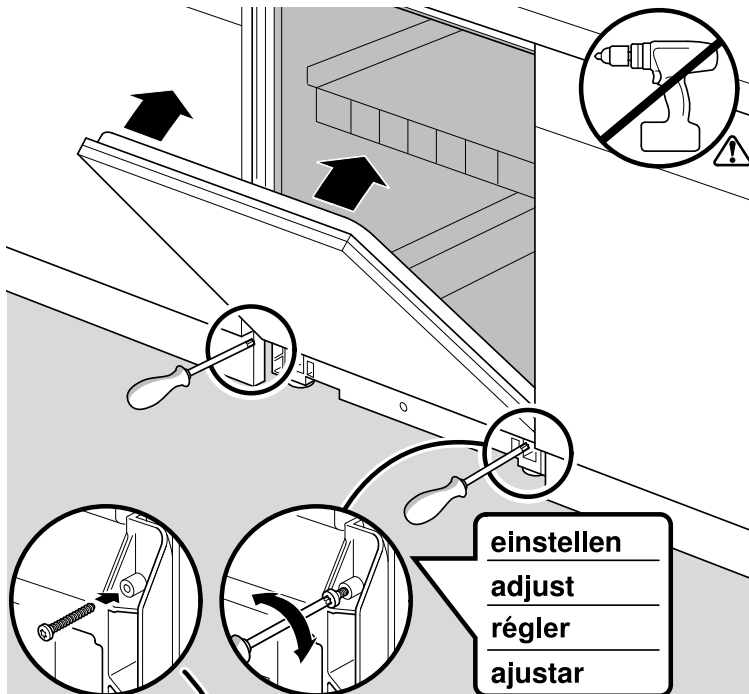
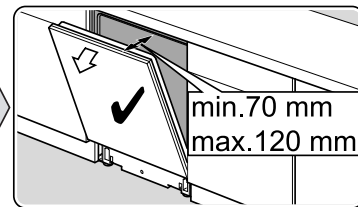
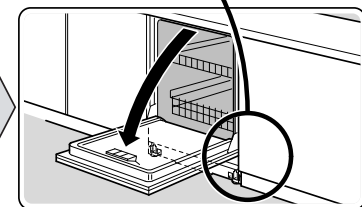
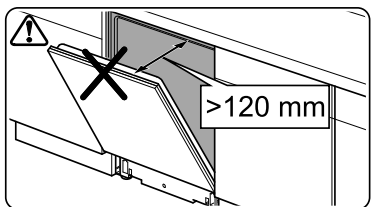
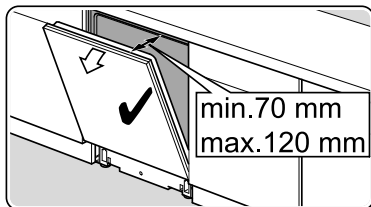
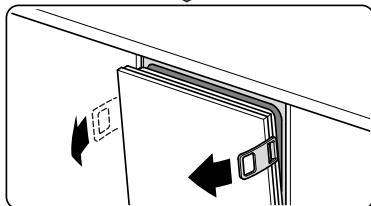
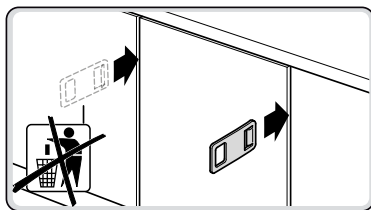
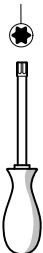

Ø4X36

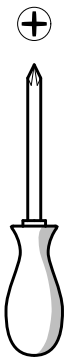
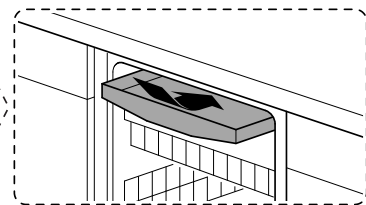
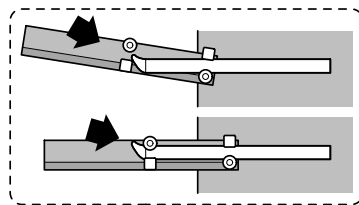
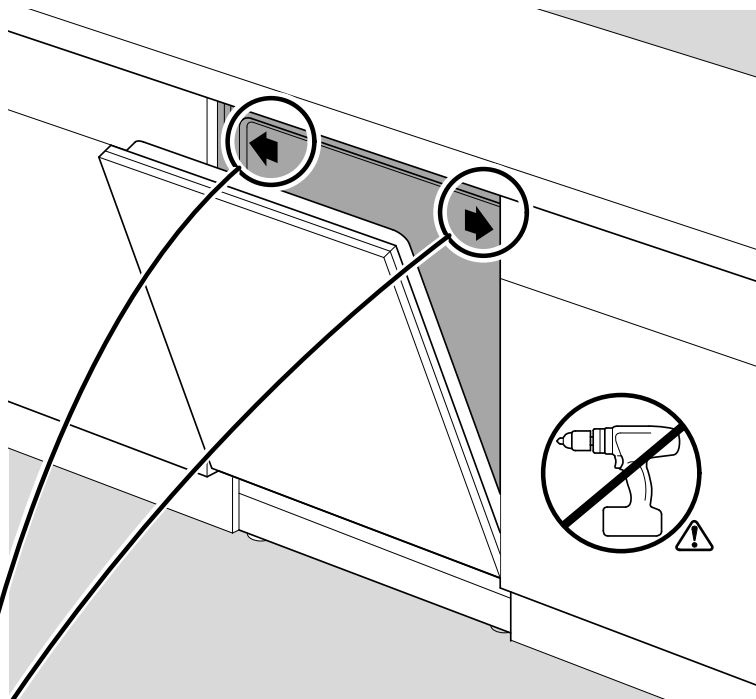
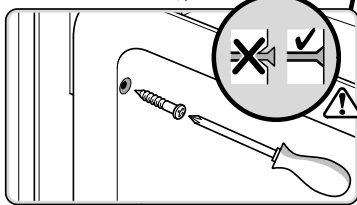
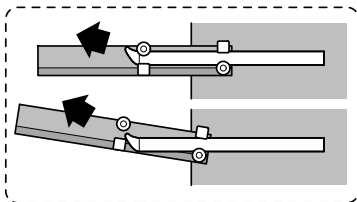
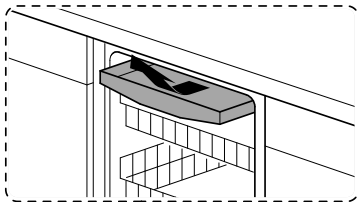
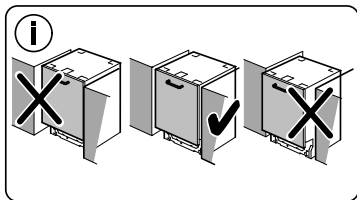
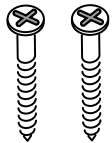

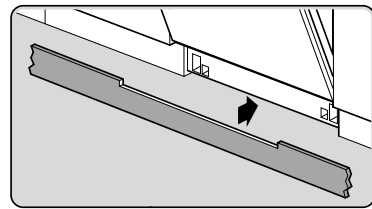
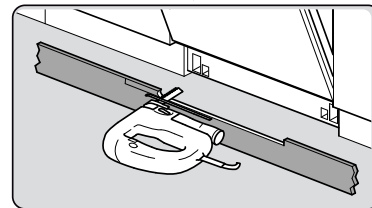
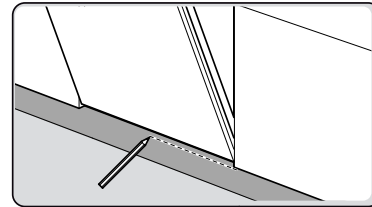
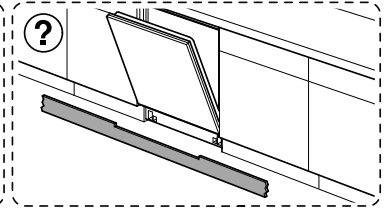
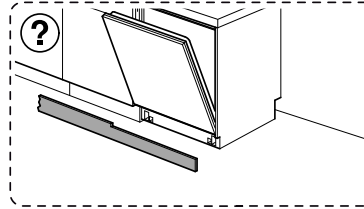
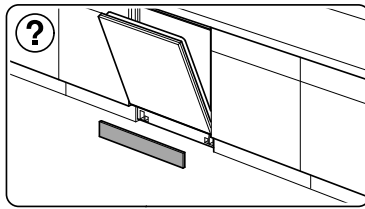
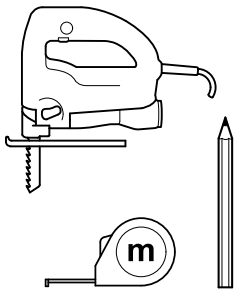

Ø4X15

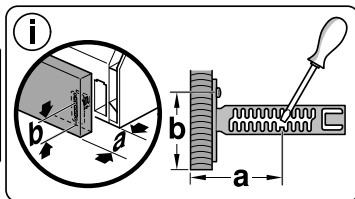
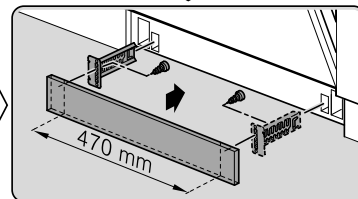
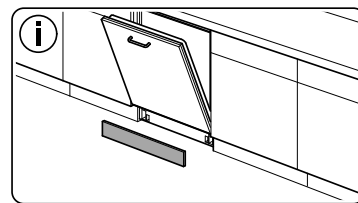
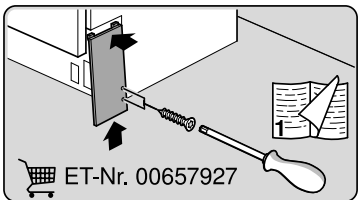
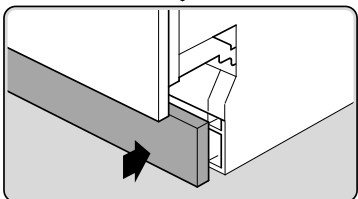
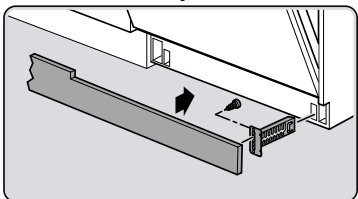
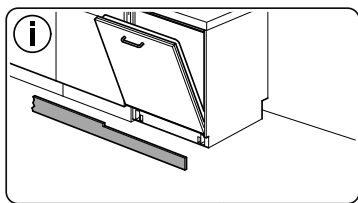
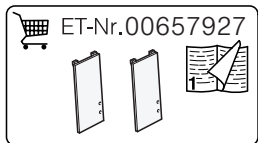
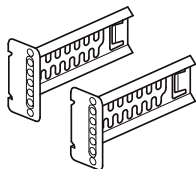

Torx
T 20

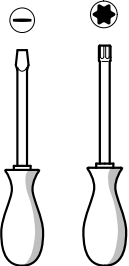

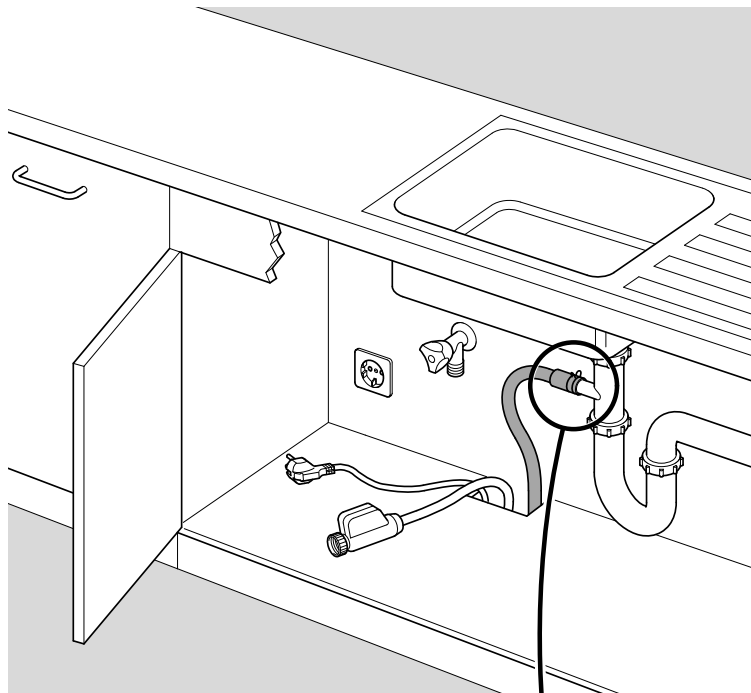
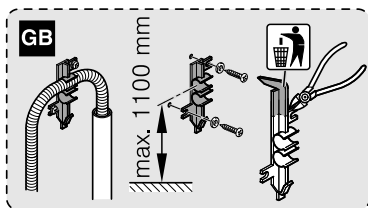
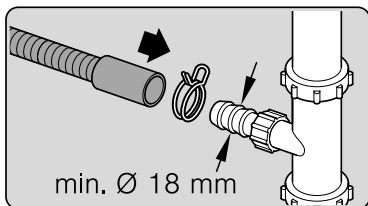
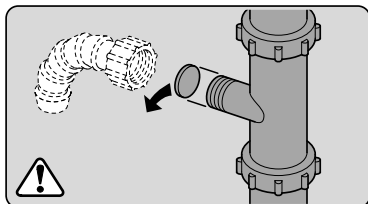
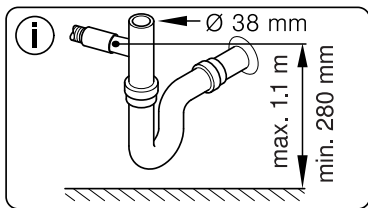
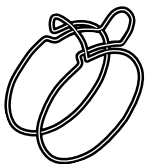

Dichtheit prüfen
Check for leaks
Verifiez l'étanchéité
Verificar la estanqueidad

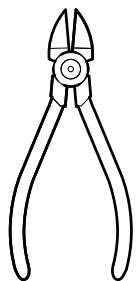
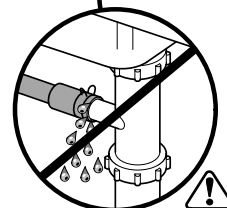

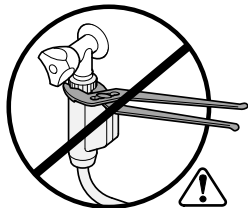
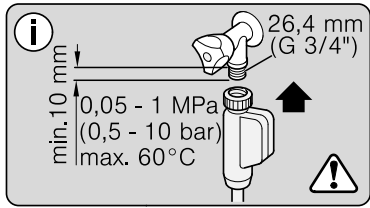

max. 10 Nm

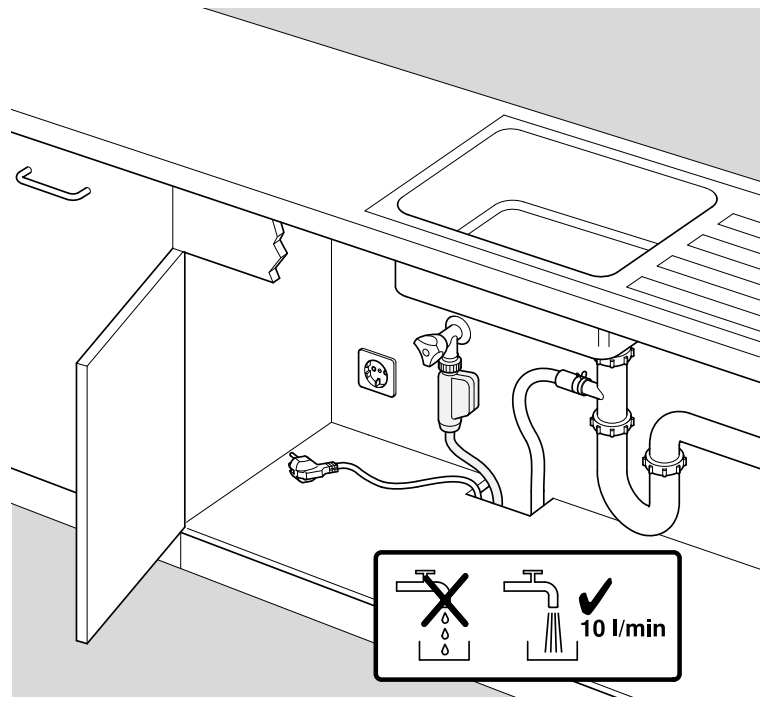

Dichtheit prüfen
Check for leaks
Verifiez l'étanchéité
Verificar la estanqueidad



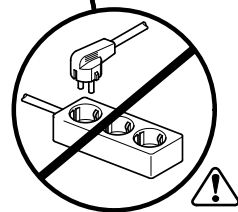
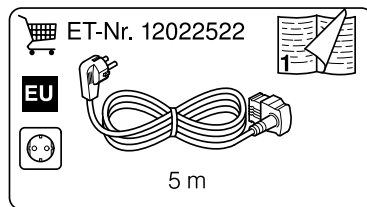
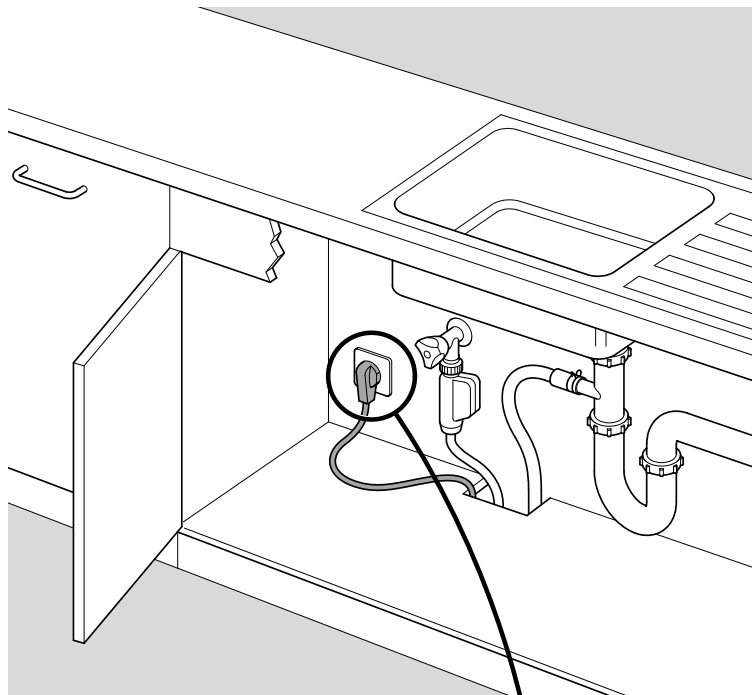
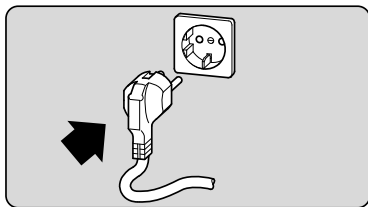



A series of horizontal lines for writing, starting from a vertical margin line on the left and extending across the page.